

The Inland Koi Connection



THE OFFICIAL
NEWSLETTER
OF IKS
ISSUE 149
JULY 2008

3:00 – 6:00 PM

**GENERAL
SUNDAY
MEETING
WITH
POTLUCK**

ONE HOUR EARIER

At the home of:

**Nick
&**

**Peggy
Milfeld**

**1644 North-
hampton Drive,
Riverside 92506
(951) 780-7395**

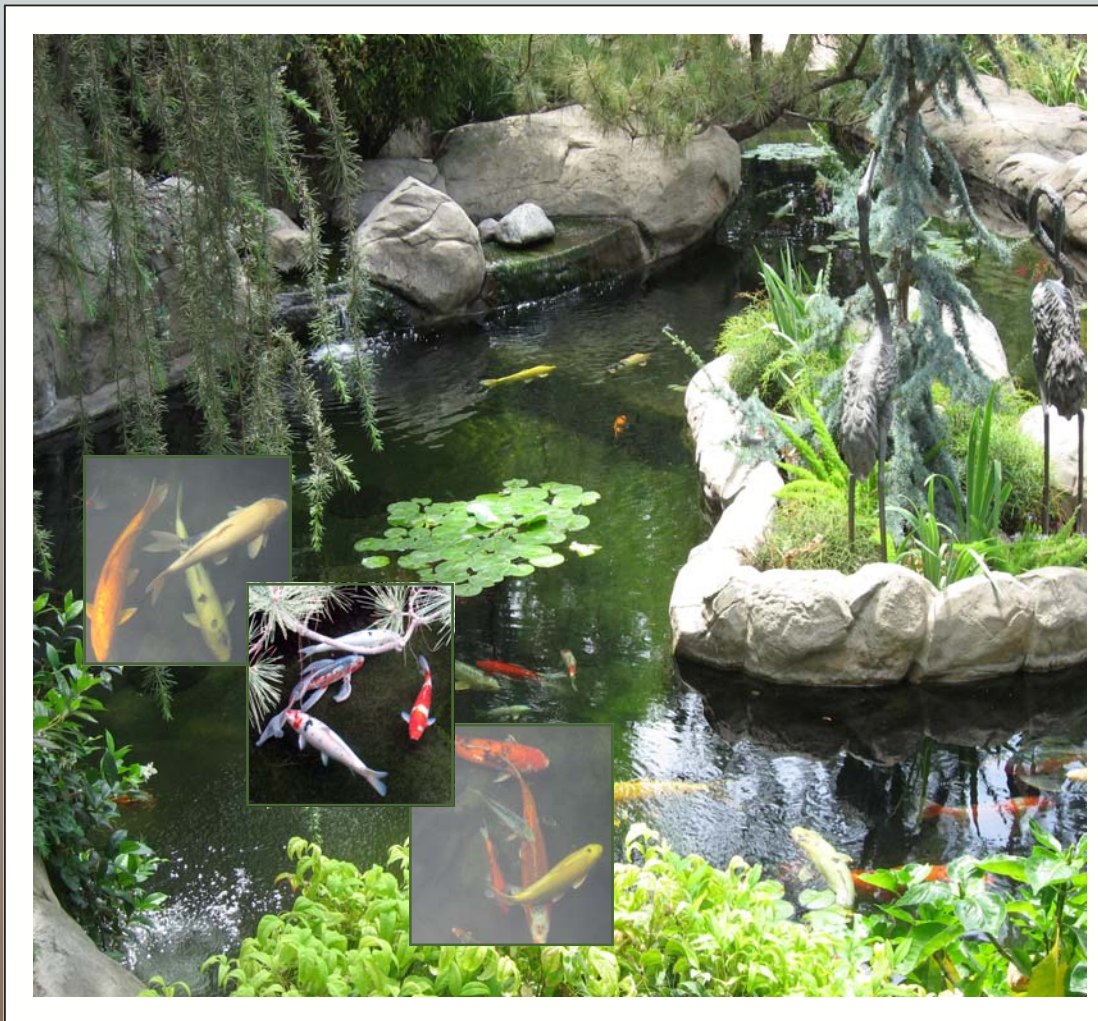

July 27, 2008

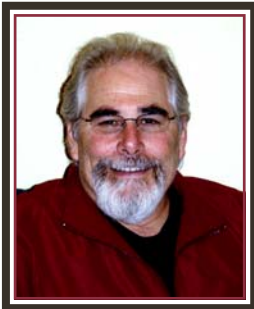

I want to WELCOME all the new club members who have recently joined the club. Since May 1 we have had 17 new families join our club. Our club depends on new members to generate fresh ideas, abilities, and challenges. In many ways, our new members are the most important people in our club. I look forward to your involvement in all aspects of the IKS. *As I would tell or encourage all our members,* please use the resources and information available to you through our club.

I just love this time of year. Coming home from work in the daylight to a beautiful summer evening and having the opportunity to spend some time outdoors with Cecilia enjoying our pond, doing some light gardening, and experiencing true serenity after a busy, sometimes hectic, day. It was an even better experience to come home after six enjoyable days in Florida to find a healthy pond full of happy koi. I want to thank Ed Kushner for watching over my pond and also extend gratitude to all the other club members who checked in on a peer's pond while they were gone to Florida or anywhere else this summer. It is great having the support of fellow club members and it makes travel a lot more enjoyable, too, knowing your fish have been left in the care of someone who understands how valuable they are to you and knows how to care for them and your pond.

It was a good thing that we took the month of May off from club activities: June proved to be even more action-packed than we originally predicted. We enjoyed a very successful Pond Tour, followed by an excellent meeting at the home of Byron and Anne Rogan. Byron and Anne have a wonderful family, beautiful pond, and awesome gardens in a very spacious back yard. Words cannot do justice to their grounds, but I will say that I felt cramped in my yard when I returned home from the meeting. Byron and Anne extended their hospitality to the club and seem to have a real zest for life. Sixty-three people attended the meeting, with 11 of these being new members, and another family joined that day. Mark Krakower was recognized for his contributions to the club as this year's Pond Tour Chairman and was presented with a framed print of this year's art work by Zuma Ross and myself. Once again our panel of koi experts (Tom Ross, Tom Wright, Nick Milfeld, Larry Leverett, Dennis Lynaugh, Theo Zoetemelk) did an excellent job answering questions presented during an open Q&A session.

And finally, 12 of our club members (who could be described somewhere between the 12 Apostles and the Dirty Dozen) wrapped up the month by traveling to Jacksonville, Florida for the AKCA Seminar. Yes, 12 hardy members made the journey across the country, not only to face a variety of weather and travel challenges, but to have a darn good time. Our group composed 7% of the overall attendance to the full seminar. Our club made a positive impact not only on the seminar, but on the hobby itself. Harlan Glenn, Chairman of the AKCA and IKS member, nominated our very own Tom Ross, KHA, to the position of Vice-Chairman of the AKCA. Congratulations, Tom, and wishing you all the best in your new role. Theo and Jeanne Zoetemelk were presented with the Kelly Houston Koi Person of the Year award to the rousing and appreciative applause of their devoted fans. Cindy and Tom Graham's Kujaku, representing the IKS, won second place in the Club Koi of the Year contest--second place out of 104 clubs! Just awesome! The host club, the North Florida Koi Club, won first place honors.

I want to thank all of you who participated in these contests; I look forward to your continued participation later this fall in preparation for the AKCA Seminar in San Diego in February 2009. Larry Leverett, a well-known favorite among hobbyists across the nation, was presented with his longevity pin for attending his 10th AKCA seminar. You're the man, Larry! And not to be left out, Mark and Fran Krakower, Theo and Jeannie Zoetemelk, and Tom and Zuma Ross "cleaned-up" at the raffle following the closing banquet. Something tells me we will be hearing more stories, exaggerated and more exaggerated, over the months and years to come regarding our trip to Florida.

Stay cool and enjoy the hobby,

Warmest Regards, *Gene*
Gene Maingot, IKS President

BOARD of DIRECTORS
Inland Koi Society
2008

PRESIDENT:
GENE MAINGOT
(951) 272-4450
gomaingo@sbcglobal.net

VICE PRESIDENT:
MARK KRAKOWER
(951) 371-2223
kraktronix@sbcglobal.net

SECRETARY:
ZUMA ROSS
(951) 354-6444
zumaross@charter.net

TREASURER:
NICK MILFELD
(951) 780-7395
milfeld@msn.com

NEWSLETTER EDITOR:
DEBBY LEVERETT
(951) 781-3887
jenniferdl1950@hotmail.com

DIRECTOR: Web Liaison
MARY LEEVER
(909) 862-3028
mary@leeveelectronics.com

DIRECTOR:
KELLY HOUSTON
(909) 885-2503
vpkelly@earthlink.net

DIRECTOR:
JACK MARRIN
(909)792-3603
jack@marrin.com

DIRECTOR: Member Database
TOM ROSS
(951) 354-6444
tomzuma@charter.net

DIRECTOR:
TOM WRIGHT
(951) 637-5479
rookiekoiguy@earthlink.net

DIRECTOR:
DENNIS LYNAUGH
(951) 780-0123
dlynaugh@pacbell.net

DIRECTOR:
ED KUSHNER
(951)520-0092
edkushner@msn.com

Inside this issue

| | |
|---------------------|-------|
| •Oval Pond | 2 |
| •Board Members | |
| •Help Line | |
| •Pond Profile | 3 |
| •Map | |
| •Directions | |
| •Support Sponsors | 4/5 |
| •June Meeting Notes | |
| •Good Mom | |
| •Dr. Hildreth | 6/7 |
| •Photographs | |
| •Pond's #1 & #2 | |
| •Pond's #3 & #4 | 8/9 |
| •Photographs | |
| •Pond's #5 & #6 | |
| •Pond Tour Banquet | 10/11 |
| •Harrison Koi Farm | |
| •Welcome | |
| •W. Lim Corp | 12/13 |
| •Ammonia Notes | |
| •Bio Filter | |
| •Inland Koi | 14/15 |
| •Photographs | |
| •Calendar / Events | |

HELP LINE

References

| | | |
|--|----------------|----------------|
| • KOI DISEASE: <i>Certified KHA</i> | TOM ROSS | (951) 354-6444 |
| • INFORMATION: | JACK MARRIN | (909) 792-3603 |
| • LIBRARIAN: <i>Books, Videos</i> | TEE WRIGHT | (951) 637-5479 |
| • MEETING SITES: | KELLY HOUSTON | (909) 885-2503 |
| • MEMBERSHIP: | TEE WRIGHT | (951) 637-5479 |
| • NEWSLETTER ADS: | DEBBY LEVERETT | (951) 781-3887 |
| • PLUMBING or FILTERS: | BOB WALTERS | (951) 681-4064 |
| • WEB PAGE MANAGER: | MARY LEEVER | (909) 862-3028 |

Nick & Peggy Milfeld have invited IKS members to hold the July General Meeting in their exquisite garden. Many of us have visited the Milfelds' garden and pond before: it has been on two IKS Pond Tours and on the Riverside Flower Show Garden Tour. It has seen two weddings, three receptions, a Women's Ministry Luncheon & Fashion Show, fifteen years of Pathway Christian Church Easter breakfasts, a fund raiser for Alvord School District, and twice been on the RCRMC Spring Garden Tour. Their yard was featured on a night-light garden tour, written about in the Press Enterprise Newspaper several times, and featured in many other events.

Nick, Peggy, and their three children built two ponds at their last home, and a prerequisite for the 1987 move to Riverside was a property that would support waterfalls (like in a forest). Nick's 'beautiful forest' vision was invisible to three of four landscape architects facing the flat, barren half acre and the 2-to-1 slope to a block-wall lot line left by the developers. But tons of rearranging, and truckloads of topsoil and amendments later, the trees got planted and the digging began.

The real adventure begins as you enter the backyard where you will find yourself magically transported to a beautiful forest of tall whispering pine, cedar and redwood trees. Nick has always said his woodland yard is the result of his inability to move Milfelds' Azalea Nursery, his wholesale family business, to the mountain environment he would have preferred. Instead, when he and Peggy moved their business and home to Riverside from Temple City, he stubbornly brought the forest to his backyard, thus also creating a lush microclimate for ferns, azaleas, rhodies and hydrangea. Recently the garden had a make-over, with trees trimmed and thinned to allow more sunlight to bathe the wealth of various flowers and trees. Be sure to take the trail that reaches into the trees among ferns where you can get a good view of the series of terraced waterfalls cascading down to the Milfelds' spectacular gunite Koi pond and swimming pool. Edging rock and waterfalls were all hand formed of concrete and painted to support an idea of naturalness. The plantings, additions and care are done by Nick and Peggy with lots of love and a pride in gardening, with constant shifts according to weather or wishes.

Their 11,000 gallon pond, with two waterfalls and an island, is to the left, and a swimming pool, with a spa and waterfall, is to the right. There is a deck in the middle which makes the pond and pool look like they are joined. Two different filter systems filter the pond. Two bottom drains feed a combination of three vortexes by Patio Ponds, with a ¼ hp Sequence pump and an Aqua UV with 120 watts back to the pond through jets. Two bottom drains and a skimmer feed the second filter system, driven by two ¼ hp Sequence pumps, first to a pair of pre-filters built by Bob Walters, then to another set of UV lights, up to a three-chamber up-flow rock-gravel-silica sand filter to polish the water; then back to the pond via a waterfall. These systems run 24/7. Nick also has a 2 hp pump that pulls water from two other bottom drains and goes straight to the giant waterfall, which runs only when there is an audience.

Nick has been our long-time club Treasurer, and

Peggy greets you at the sign-in table at each meeting, helps proof the Inland Koi Connection, and has created the IKS Pond Tour booklets each year. Because of their dedication and constant involvement, both have been elected as an IKS Person of the Year in the past. You couldn't find a better example of unselfish giving and friendship in our club than the Milfelds.



Nick and Peggy have a beautiful swimming pool, and with this heat, it might be a refreshing treat to dip your feet in. Of course, it is an option for 'kids' of any age to swim, but please bring your own suits and towels. The pool is only 4½ feet deep, so there is NO DIVING, but kids are free to play in the water-fall. The house rule is to go to the bathroom before a swim. Please remind the kids.

Since June, July, August and maybe September in the Inland Empire are extremely exhausting with high outdoor temperatures, the IKS Board of Directors have directed a time change; hoping to catch a cooler time of day. So, this month, the starting time of the meeting will be changed from 2:00 PM to 3:00 PM and then plan to end at 6:00 PM

Remember your comfortable chairs... any raffle gifts... and an attitude for relaxing while learning about Koi. We have exceptional potlucks with homemade and purchased items. I do hope you'll join in on contributing *your* favorite summertime dish or treat.

I'll see you there,
Debby Leverett, IKS Newsletter Editor

Program: The program had not been confirmed at printing time of this newsletter, but Kelly is promising something spectacular.

From 91 Freeway in Riverside, exit on Madison Street.

- Go approx. 1 mile south to VICTORIA AVE., an old divided street, and turn left.
- Turn right on WASHINGTON at the 4-way stop; turn left at signal on OVERLOOK.
- Take the first right (ALTON WAY), go right at the 'T', and then you're forced left. Go 2 blocks, turn left. it's the second house on the right.

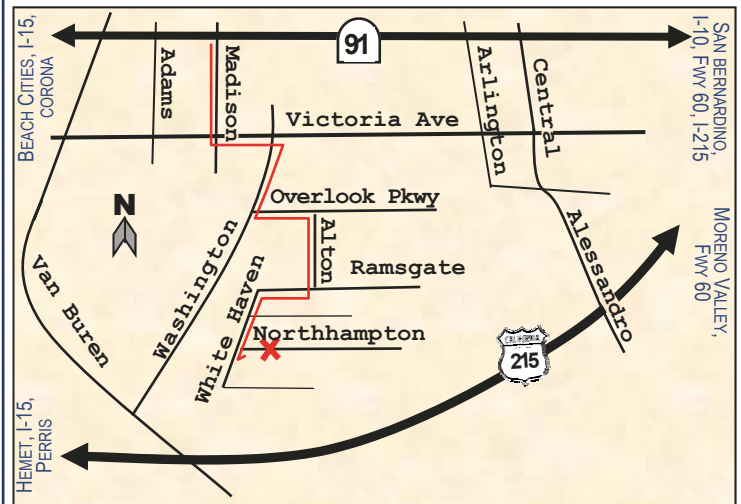



JACK CORDS
 11800 Sterling Ave., Suite G
 Riverside, CA 92503
 printingcolor@yahoo.com
 www.printingconnection.net
 800.491.1964
 951.351.9437
 Fax 951.351.4574



8151 Auto Drive • Riverside, CA 92504-4190
 (951) 688-6200 Ext. 1160 • 1-800-BOSS-MOSS • Fax (951) 688-8314
 www.mossbrosdodge.com

"At Moss... You're The Boss!"



- ◆ Koi Pond Filtration
- ◆ Installations and Modifications
- ◆ Your UV Lamp Source
- ◆ Contractors Lic. #716692

Robert Walters ~ 951 205-1212
Scott Zehm ~ 951 237-2508



909-981-1731
 www.thepondexperts.com

Jim Thompson
Debi Thompson
 Contr. Lic #824893

1088 W. 9th Street • Upland, CA 91786
 Specializing in Koi Ponds, Filtration Systems & Watergardens
 DESIGN • CONSTRUCTION • RETAIL EQUIPMENT & SUPPLIES



LAGUNA KOI PONDS

Ben Plonski
 Phone (949) 494-5107
 20452 Laguna Canyon Road, Laguna Beach, CA 92651
 bplonski@lagunakoi.com Fax (949) 494-1679



Leo's Construction

Driveways • Universal Flagstone • Block Wall
 Brick • Ponds • Waterfalls

LEO PALOMARES (626) 960-6157

Cassie was a really good mom.

When her children were growing up, her one son gave her more "Don't kill! Stop and count to 10" moments than all the others together.

Once, after he fell, or jumped, into the pond and came home with his good school clothes dripping wet, the exasperated Cassie sent him to his room while she washed and dried his clothes.

A little later, Cassie heard a commotion in the back yard. She called out "Are you out there wetting your pants again!?"

There was dead silence for a moment. Then a deep, masculine voice answered meekly, "No, ma'am, I'm just reading the meter."

● **DID YOU KNOW!**

- The Spring / Summer issue of our Microbe-Lift Watergardener is now available! Have you picked up the
- Spring/Summer '08 issue of the Microbe-Lift Watergardener magazine from your local retailer yet?? You
- can also view the magazine and all the past issue on
- our website here: <http://microbelift.com/htmls/video.php>

● Reprinted from Microbe-Lift Newsletter, publication of Ecological Laboratories, Inc.

- P.O. Box 184
- Malverne, NY 11565
- info@MicrobeLift.com
- Toll Free: 1-800-645-2976



2008 IKS SUNDAY GENERAL MEETING ~ JUNE 22, 2008 ~ RIVERSIDE

IKS president Gene Maingot opened the meeting.

POND TALK-After a short meal break, Byron Rogan talked about their pond. The pond is actually two large "lakes" connected by a short stream with a bridge. They were spectacular. The landscaping included many tropical plants, several beautiful water lilies in bloom, and other water plants. The ponds are about 2 years old. The fish looked happy, and large. The ponds do not have a bottom drain, but they are kept clean and in good condition with the help of a good pond vacuum, and a lot of effort from their son.

WELCOME-Gene then introduced the many new members and guests, and asked each one to talk about their ponds. Most of the speakers had ponds, or were planning ponds. Welcome to all. We hope you join the Inland Koi Society, and we will be able to see your ponds and share our experiences with all of you. Gene extended a welcome to all, and asked them to call us with questions, and problems. Gene indicated the mission of the IKS is to educate people about Koi, and to promote the hobby.

AWARD-After Gene's welcome, Zuma Ross, the t-shirt artist, and Gene presented a framed print of this year's t-shirt art to our 2008 pond tour chairman, Mark Krakower, as a tribute to him and his effort.

THANKS-Gene then thanked Debby Leverett for her excellent job as newsletter editor and asked for volunteers to call Debby to offer her help in publishing and mailing the newsletter.

KOI RESCUE- Gene indicated he had received 3 calls to rescue Koi the day before the meeting. The club now is caring for many rescued Koi. More quarantine tanks are needed. If anyone has space for rescued Koi, their help would be appreciated. The rescued Koi will be sold or

distributed during the club's next Koi auction.

QUESTION AND ANSWER- The next agenda item was a question and answer period with a panel of experts. The experts were: Theo Zoetemelk, Tom Ross, Nick Milfeld, Tom Wright, Dennis Lynaugh, and Larry Leverett. There were many questions. The audience was actively involved. The questions sparked discussions about the amount and frequency of water changes, how to deal with chlorine and chloramines in the water supply, how water softeners effect Koi and pond health, are turtles OK in a Koi pond, and questions related to spawning fish and nutrition of young fry.

CLUB RAFFLE- After a short break, Mary Leever and Byron Rogan performed the club raffle. Byron called out the numbers. There were raffle items for both adults and children. The meeting was then concluded.

CONCLUSION-This was a really good meeting. The day was warm and sunny. The house, gardens, and pond were, in a word, spectacular. The newsletter description was not an exaggeration. Many guests may have attended just to see the pond. The Rogans were very gracious and made all of us feel welcome. The food was good and plenty. The discussion during the question and answer period was lively, and the information was of value to everyone. Zuma Ross, IKS Secretary

A SPECIAL THANK YOU

to local Riverside dealer, INLAND KOI, for donating beautiful young koi in the June club raffle! See their advertisement on page 14.



SUMMER TIME TIPS FOR THE HUMANS OF KOI

Ants:

Take a 4 oz. spray container and fill it with 3 oz. of alcohol (vodka). Then add 1 oz. essential oil of lavender. Spray the entry point and trail of ants. You need just a little bit so this container will last a long time and the solution works better than the most powerful chemical products.

Flies:

Lavender can safely be sprayed around food and picnic tables to keep flies away.

Sunburn:

Add a few drops of lavender essential oil to mineral water and spray on sun-burned areas. (Or use our Aloe Lavender Gel!)

Web: <http://thelavenderfields.com>

Wednesday, June 11, 2008

It's not sushi, but you won't believe what Dr. Bob does with a scalpel and a fish **By TOM BERG**

THE ORANGE COUNTY REGISTER

THIS IRVINE VETERINARIAN ONCE REMOVED A 3-LB TUMOR FROM AN 11LB FISH. HIS PRICIEST PATIENT WAS AN \$80,000 KOI.

KOI KICHI

Dr. Bob never intended to be a fish surgeon.

He was your typical dog-and-cat veterinarian who'd seen a few fish when he got called to a koi show. It seems a woman in the finals had a koi with a torn fin so naturally the reaction was: EVERYBODY PANIC!

The real fear was that a woman might actually win (in 1995, koi shows were an all-male domain), but the expressed fear was that her wounded fish might have a deadly bacterial disease – aeromonas– that could spread through the tanks.

Dr. Bob rushed over.

"It was obvious this fish got caught in a net," Dr. Bob says. "It was a very minor injury, but people were panicking."

Tammy Davis decided to withdraw her koi anyway – just in case. Then she asked the young fish doctor to check the rest of her koi stock at home – just in case. They talked for four hours. Soon they were dating, then married.

"They call it *koi kichi*, which means koi crazy," Dr. Bob says of the passion koi owners exhibit. "Well, that's how I met Tammy."

Soon Dr. Bob had koi kichi himself. He fell in love with Orange County's koi community – which includes the oldest koi club in America.

"The people were nice," he says. "They had beautiful fish. I was willing to learn from them and they were willing to learn from me."

He introduced a new concept to these koi-crazy owners: science. It was a turning point.

"Up to that point, it was hit or miss," says Pam Spindola, of North Tustin, a nationally known koi judge and former grand-champion winner. "We called it the shotgun approach. If a fish had an abrasion, you'd start with simple Mercurochrome."

Dr. Bob tested for viruses and parasites. He introduced microscopic exams and the judicious use of antibiotics on fish. And more.

When he encountered an 11-pound koi with a 3-pound tumor, he introduced Orange County to fish surgery.

SEEING IS BELIEVING

Yes, he's performed fish cancer surgery, facial reconstructions and fin splints. He's operated on an \$80,000 fish. Appeared on Animal Planet's "Beverly Hills Vet." And even played a fish's "favorite music" to help it recover from surgery.

Tammy was there. The owner kept calling, asking

how her koi was recuperating. Tammy said it seemed happy but wasn't eating. To which the owner replied: "You need to turn on opera music. And sing to the fish. And you need wine!"

That's how its owners ended each day – listening to opera, sharing a glass of wine and sitting by their koi pond. Well ...

"As soon as I turned on the opera," Tammy says, "the fish started eating."

What does Dr. Bob, a nationally known fish surgeon and lecturer, think about all this?

"Seeing is believing," he says. "I don't know how to say it other than that."

The truth is, fish have all five senses we do plus they can feel vibrations in the water. Tammy's koi recognized the sound of her door latch when she walked out to feed them. Other koi recognize their owner's footsteps. They'll swim up and settle on top of their hands.

"These fish can live 30 years," says Dr. Bob. "They become part of the family, as much as the family dog."

Before you get too lathered up, a quick history lesson: Two centuries ago, if a vet even looked at a dog, the act would've been seen as borderline insane. The first veterinary college opened in Lyon, France, in 1762, to keep the primary engines of transportation and war – that is, horses – running. Over the next century, vets extended their clientele to cows, sheep and other farm animals to assist agriculture.

It really wasn't until Americans fell in love with "Lassie" in the 1950s that sick dogs were no longer put down. Since then, the U.S. pet industry has grown into a \$41 billion-a-year business that includes not only dog surgery, but cat surgery, bird surgery and so on.

Can fish really be far behind?

"I have to tolerate a lot of jokes," Greg Lewbart, a professor of aquatic animal medicine at North Carolina State University in Raleigh, says of the typical flushing and grilling jokes that accompany talk about sick fish. "That's just part of people getting accustomed to it."

Lewbart knows people who've taught goldfish to limbo (swimming under a bar); people who sleep on the floor next to their aquarium with a sick fish; and people who've spent \$500 to heal a \$1 fish.

Why? Money is not a factor, he says. People spend thousands on sick dogs and cats they got for free. He says he'd easily spend \$2,000 to save the snake he's had since 1982 – adding, "This is an animal that probably wouldn't know me from you!"

Why then? What is it?

TO BE CONTINUED IN THE AUGUST INLAND KOI CONNECTION...



STEADY NOW: Dr. Hildreth moves the patient, a 26" koi fish, into a separate tank to be anesthetized.

He uses an anesthetic powder in a separate tank to knock the fish out for surgery.



FISHY WORK: With the fluoroscope off, vet tech Jesse Nunez keeps water flowing into the mouth and over the gills of "George," a 30" koi fish undergoing treatment for an infected swim bladder.

STEVE ZYLIUS, THE ORANGE COUNTY REGISTER

EDITORS NOTE: All pond descriptions respectfully written by **Peggy Milfeld** and included in this year's Pond Tour Booklet. All Pond Tour Photographs taken by **Tim Card** and graciously donated to the Inland Koi Society. Give these volunteers a special thank you when you see them again! DJL

POND # 1 IN CORONA

Owners: Ed Kushner and Linda Vanore

Wanting both koi and water garden in a natural setting, this flag lot provided great borrowed landscape on all sides - an unrestricted view into the Cleveland National Forest! The pond stretches across most of the backyard, turning the patio into a private retreat. A solar energy system generates all the power for the pond and half of the power of the house.



HOORAY TO ALL POND TOUR VOLUNTEERS...YOU WERE MARVELOUS!

POND # 2 IN CORONA

Owners: Gene and Cecilia Maingot

This is the almost inevitable second pond, an expansion of the first. Hand-dug into hard-packed DG and clay. 82 tons of soil were removed. Designed for low maintenance, it is deeper to foil the herons. A 2" deep bog planter is a bonus to the filtration and allow plants to thrive separate from the fish. Built in 2004, it has been upgraded since to improve filtration.

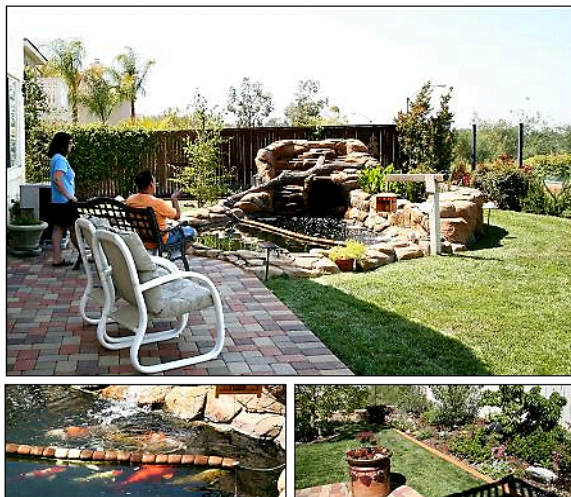

POND # 3 IN CORONA

Owners: Mike and Mickie Brooks

"Let's just keep it simple and see what happens!" After 40 years this house got a major make-over, including a new koi pond. Owner built, this was a very doable project for a small yard or just a small space, proving that inexperience and limited budgets shouldn't stop anyone. Total cost was under \$3000; admittedly, the filter and UV light came secondhand from a friend. It's the finishing touch to the patio—unobtrusive yet an eye-catcher—tied to the far end of the pool by raised planters and shade sails. And the relaxing music of splashing water can be enjoyed from indoors or out.

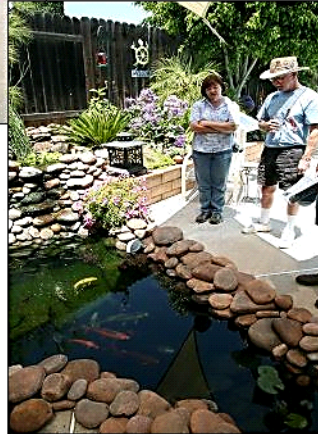
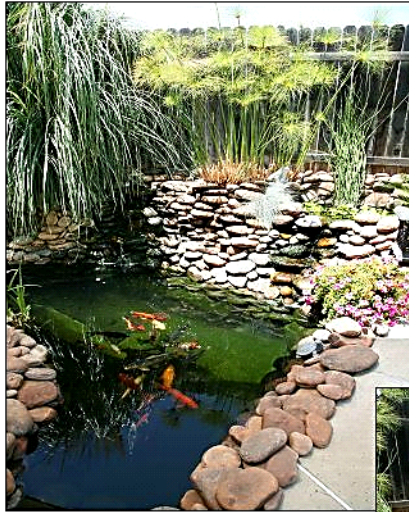

HOORAY TO ALL POND TOUR VOLUNTEERS...YOU WERE MARVELOUS!

POND # 4 IN CORONA

Owners: John Cress and Marcia Seals

When John and Marcia visited an IKS meeting in February 2002, they joined on the spot, then listened and researched for a year. We've watched their pond develop since January 2003 when the club met around a big hole in their yard to hear a local legend speak on pond construction. Members became friends and helped design the filter system and assisted with the plumbing. Koi are contagious—which is how many people get started—so the first lesson we try to teach is "Go slow, learn all you can, and build your last pond first."

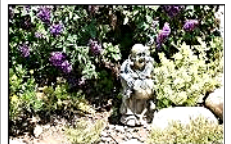
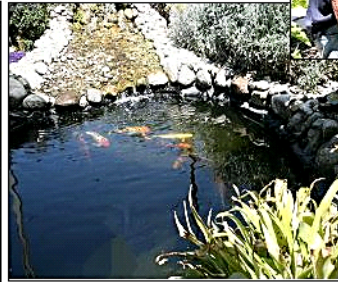

POND # 5 IN CORONA

Owners: Mark and Fran Krakower

Sneak through the side gate and catch the long view of this owner-built pond. Change is constant here; the first waterfall you see, cascading down to a small catch basin, was a beginning. Put liner pond at the far end...replace the spa with another pond...add a new waterfall in between... Logic said to connect things, hence the small stream-like waterway. Still not big enough, the liner pond gave way to concrete and another waterfall. Design and construction has been at least a ten year process, and this may not be the final form... there is unbroken ground out there!

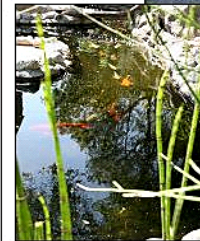

HOORAY TO ALL POND TOUR VOLUNTEERS...YOU WERE MARVELOUS!

POND # 6 IN NORCO

Owners: Tim and Pansy Law

Come in, sit down, relax... This cul-de-sac site is actually a three-level parcel with hilltop home, mid-level garden, and bottom-of-the-hill area maintained by the HOA as a trailhead for local horse riders. The Pond isn't that old, but it was built as a natural rock-bottom design and has presented problems. As the fish load increased, the Laws realized the design had been a big mistake and they started pulling rocks out, Repositioning them around the edges and in the landscape. And the filtration system, totally inadequate for koi, had to be redesigned to handle the fish wastes and other debris.

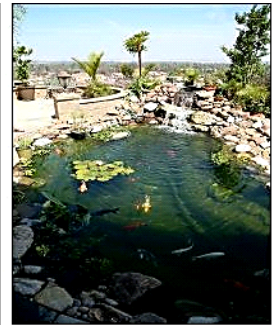



Photography Courtesy of Tim Card



T-shirt designed by Zuma Ross



Mark Krakower, 2008 IKS Pond Tour Chairman
Banquet provided by Zoetemelks

These IKS Members are appreciated for Opening Their Yards and Sharing Their Ponds with the public during our 2008 IKS Koi Pond Garden Tour!

The Inland Koi Society has members who are THE BEST!!!!

THANK YOU
THANK YOU
THANK YOU



Marcia Seals & John Cress

Mickie & Mike Brooks

Tim & Pansy Law

Ed Kushner & Linda Vanore

Fran & Mark Krakower

Cecilia & Gene Maingot

WELCOME

| <i>NEW MEMBERS</i> | <i>CITY</i> | <i>JOINED</i> | <i>NEW MEMBERS</i> | <i>CITY</i> | <i>JOINED</i> |
|----------------------------|---------------|---------------|---------------------------|------------------|---------------|
| DENNIS & JERILIN CUMMINGS | MENIFEE | 06 - 08 | JOEL & PATTI PARKER | MURRIETA | 06 -08 |
| GARY & SHARON DIBBEN | VICTORVILLE | 07-08 | RANDY & JOAN REDDEN | RIVERSIDE | 06 - 08 |
| RICK FARAG | RIVERSIDE | 06 - 08 | ROSS & BONNIE RETTIG | REDLANDS | 05 - 08 |
| JOHN & LANA FUTRELL | NORCO | 06 - 08 | GEORGE & BARBARA SCHRADER | BEAUMONT | 06- 08 |
| MARY GODSHALL | CORONA | 06 - 08 | ANTHONY & KAILEEN SPATOLA | RIVERSIDE | 04 - 08 |
| BOB, BONNIE, & ERIKA HENRY | GRAND TERRACE | 06 - 08 | LARRY & GLYNN THOMPSON | RIALTO | 07-08 |
| GARY & ALICE JACKSON | PERRIS | 06 - 08 | ERIC & BRANDI TROXEL | RIVERSIDE | 06 - 08 |
| DAVID & CLAUDIA KING | NORCO | 06 - 08 | GREG & PATTY UEMATSU | TRABUCO CANYON | 06 - 08 |
| AL PALACIO | RIVERSIDE | 06 - 08 | LARRY & DOROTHY WOLF | RANCHO CUCAMONGA | 06 - 08 |

IKS HOPES YOU ENJOY A FUN AND INFORMATIVE ASSOCIATION WITH OUR CLUB! FOR EXTRA HELP, QUESTIONS, OR INFORMATION, BE SURE TO REFER TO THE 'HELP LINE' ON PAGE TWO.

(951) 369-9998



HARRISON'S

KOI

FARM

POND KOI - SHOW QUALITY KOI

2000 KOI on display from 3" to 30"

Specializing in hard to find varieties

- KOI FOOD
- SUPPLIES
- EQUIPMENT
- CONSULTATION



Terry & Koren Harrison
5580 / 5582 Rio Road
Riverside, CA 92509

W. Lim Corporation
11095 Inland Avenue
Mira Loma, CA 91752
Tel (951) 360-7878 Fax (951) 360-1166



DRAGON Series

Industrial Baldor Motor
custom built for
W. Lim Corporation

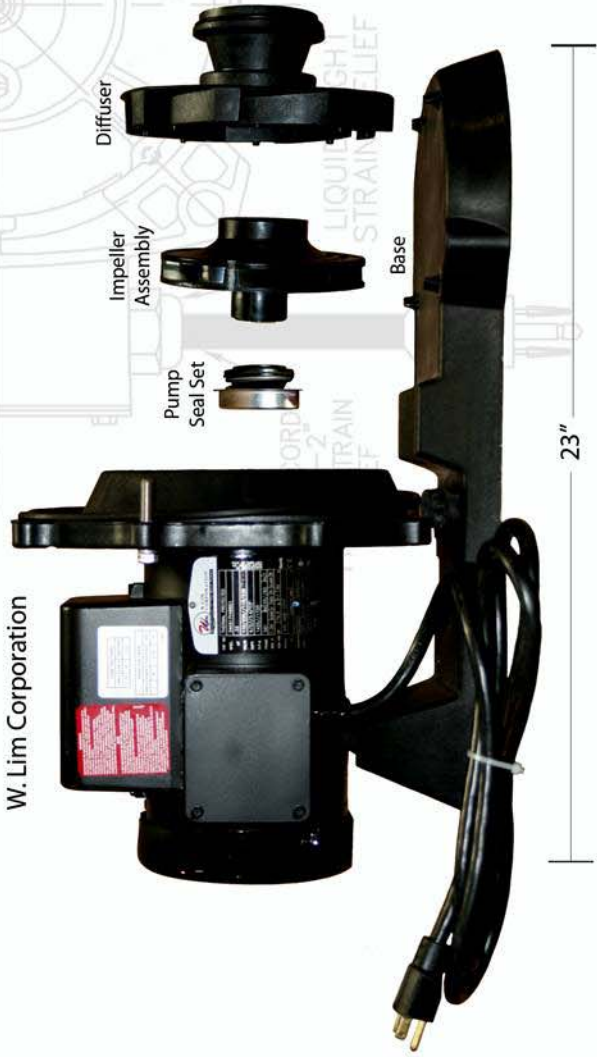

Model Shown: Dragon 1/3 HP



KHA Korner – Ammonia **by Mike Anger, KHA**



“Water, never touch the stuff, heard Koi spawn in it...” (this is a family read newsletter).

When we examine the health of our Koi, almost without fail predating whatever illness we diagnose is a problem with water quality. We all know this, but all too often we are lulled into a false sense of security because of the clarity of our water and the findings of a normal pH and temperature. Is that all we should be monitoring? Why is it that we spend hundreds or even thousands of dollars on fish, yet we sometimes skip the ten or twenty dollar purchase of an ammonia or nitrite test?

Remember that even a crystal clear pond might contain toxic levels of chemicals potentially lethal to your fish, while an algae bloom might look terrible (and make it difficult or impossible to see your fish) but actually might be beneficial to your fish.

Our ponds are artificial self contained ecosystems. Koi are *ammonotelic*, that is the majority of their nitrogenous waste is excreted by diffusion (the movement of a substance from an area of higher concentration to one of lower concentration attempting to achieve equilibrium) via the gills into the water as ammonia. Ammonia is excreted in two forms: NH_3 the toxic form, and NH_4^+ the ionized and non-toxic form. The relationship between these two forms is greatly pH and temperature dependent. The higher (more alkaline) the pH, the greater the amount of (toxic) NH_3 , while the lower (more acidic) the pH, the greater the amount of (non-toxic) NH_4^+ . The colder the water, the more NH_3 , the warmer, the more NH_4^+ .

Because of Koi's body temperature and blood pH, most excreted ammonia is in the form of NH_4^+ ; this can change quickly depending upon the pond environment. Our biofilters become populated with families of bacteria that convert ammonia to nitrite. Nitrite is also a very toxic substance. Unlike ammonia, it does not come directly from Koi, but is formed almost solely in the filter or source of that family of bacteria. Because nitrite does not come from the Koi, when it contacts the Koi's gills it enters the fish by diffusion (again from the area of higher concentration, the pond, into the lower concentration of the Koi blood) binding hemoglobin in blood rendering it unable to carry

oxygen. A second population of bacteria grow in our biofilters to convert nitrite to nitrate, fairly harmless to Koi but usable by algae and plants. As the Koi eat the algae and plants, this cycle begins all over again. The bacteria that convert nitrite to nitrate are the most susceptible to aberrations in water quality and are therefore the first to decrease in number.

Causes of excess ammonia and/or nitrite may include overstocking, overfeeding, low oxygen saturation, an undersized biofilter, an immature filter (the bacterial colonies have not increased to a sufficient number yet such as in the spring), a dirty filter, a filter too aggressively or frequently cleaned (especially if tap water is used), or chemical treatments that may harm the bacteria.

Symptoms of high ammonia may include lethargy and red streaking. Symptoms of high nitrite may also include lethargy (sometimes lying on the pond bottom, though swimming up for food before going down again) and flashing.

There are two types of test kits for ammonia, Nessler and Salicylate. The former uses one drop or tablet and the color goes from clear to shades of yellow. The latter uses two steps of drops or tablets and goes from yellow to shades of blue or green. The problem with the Nessler test is that if you are using treatments in the water that bind ammonia it still reads ammonia being present while the salicylate will not. Nitrite tests usually will change from clear to purple.

Treatment for high ammonia may include water changes to dilute it, binders such as Amquel, or Zeolite rocks which absorb ammonia from the system. Remember that salt in the system greater than 0.3% will release the ammonia bound to the Zeolite.

Treatment of high nitrite includes water changes, suspend feeding, salt to 0.3% and increased oxygenation.

In all cases try to address the underlying cause, especially checking your filter. In the spring check these water parameters with your test kits daily until your bacterial colonies are populated, then weekly, and when stable one each month.

These simple precautions may prevent a small problem from evolving into a disaster! ❖

BIOLOGICAL FILTER

A biological filter is a vital part of any pond system. This chamber (or chambers) follow the mechanical filter. A good, long-established biological filter should be home to a colony of aerobic bacteria that convert toxic ammonia to less harmful nitrates. This bacteria can be boosted with regular additions of polybac or ABA (ask your local Koi dealer).

www.koikorner.com

In Loving Memory of Charles S. Cloud
 Born: February 26, 1948
 Passed: May 7, 2008

Chuck was a man of Military Honors and a diligent, honest and hard working gentleman. He was also a man of integral joy; his ability to hold an audience captive with his many jokes and stories will live on forever. Chuck made friends easily and world wide in his travels; he had a love of people and a love of God. Chuck and Alice were married in 1970. He had a desire for koi, so she designed the koi pond he built at their home in Wildomar and they were on the 2005 Pond Tour.



Chuck was in a serious motorcycle accident and healing well, then he developed a blood clot. He was laid to rest in the Riverside National Cemetery on May 14, 2008. He will always be remembered and missed by those who knew him in the Inland Koi Society.

INLAND KOI

Quality Japanese Koi
 & Pond Supply



Importers of high quality
 Japanese koi.
 Complete line of koi &
 pond supplies.

4337 Ardsley Court
 Riverside CA 92505



Store Hours: Mon-Sat 10:00-5:00
 Sun 10:00-4:00

Phone: (951) 352-5128
 Email: inlandkoi@inlandkoi.com

THE BEST QUALITY
Japanese Koi
 AT A REASONABLE PRICE!

**INLAND KOI SOCIETY
PROGRAM PLANNING CALENDAR 2008**

| REGULAR MTG 4th Sunday | HOSTS Address | PROPOSED PROGRAM Speakers | BOARD Wed. after Mtg |
|---|---|---|-------------------------|
| July 27 | Nick & Peggy Milfeld 1644 Northhampton Riverside 92506 (951) 789-7395 | Pending | July 30 |
| August 24 | Pat & Jerry Mall 43024 Via Las Rocas Temecula 92590 (951) 506-4814 | Shawn DeBrosky of Mystic Koi – Topic to be determined | August 27 |
| September 28 | Pending: Bus Tour | | Oct. 1 |
| October 26 | Pending: T. & Z. Ross | | Oct. 29 |
| November 23 <i>Thanksgiving 11/27</i> | Mac & Jill McClain 16130 Red Pony Lane, Riverside, 92504 (951) 398-7048 | | Nov. 26? |



IKS BUS TRIP 2008

For this year's bus trip, the club will be visiting several koi ponds and a koi dealer in the Orange County area. The trip is planned for Sunday, September 28 in lieu of our regular general meeting. As in past years, the cost will be \$5.00 per person which will include transportation to the koi ponds and koi dealer and will include our famous tailgate breakfast as in years past.

The pond owners will include Burt and Gloria Ballou whose main pond is a converted swimming pool of more than 30,000 gallons. Their pond has been featured in several koi magazines and contains many jumbo grand champion quality koi. We are also scheduled to visit the pond of Mark and Charlene Whelan whose pond is over 6 feet deep and features a 15 foot wide waterfall. Additional ponds will feature exquisite landscaping and current and former grand champion koi show winners.

We will also visit Eastern Nishikigoi, one of the premier koi dealers of Orange County. The owner of ENKOI, Ken Tran, will provide a tour of his facility including his large Grand Champion koi selling pond complete with his Bakki Trickle Tower Filters.

Further information will be available at our July and August IKS general meetings as well as advance sign up sheets.



**CELEBRATING
OUR
CULTURE AND COMMUNITY
August 16-24, 2008**

**Matsuri
is the
Japanese
word for
festival**



Summer Music Festival

www.redlandsbowl.org

Friday, Jun. 27, 2008 Friday, Aug. 22, 2008
A night of music fills the air, featuring various artists and different styles of music. Every Tuesday and Friday throughout the summer enjoy music under the stars.
Location: Redlands Bowl / Brookside Avenue at North Eureka Street / Redlands, Ca 92373
Hours: Friday and Tuesday 8:15pm
Admission: Free
Phone Number: (909) 793-7316 **Fax Number:** (909) 793-5086

2008 Coming Events

| | | |
|------------------|--------------|--|
| J U L Y | 11 To Aug 03 | 2008 ORANGE COUNTY FAIR ~ Tuesday-Friday, noon-midnight / Saturday & Sunday, 10 a.m.-midnight / Closed Mondays. Admission: adults \$9, seniors (60+) \$7, children (6-12) \$5, children 5 & under admitted free every day. www.ocfair.com |
| | 16-20 | SUMMER BOUTIQUE ~ 2008 Arts & crafts Festival. Wed-Fri, 10am-8pm / Sat-Sun, 10am-4pm / Summer décor & Holiday pleasures / 400 N. Main St. / Corona |
| | 18 | REDLANDS SUMMER MUSIC FESTIVAL ~ 8:15 pm. See article at the bottom left for more info. |
| | 25 | REDLANDS SUMMER MUSIC FESTIVAL ~ 8:15 pm. See article at the bottom left for more info. |
| | 27 | IKS GENERAL MEETING & POTLUCK ~ 3:00 pm - 6:00 pm . Hosts: Nick & Peggy Milfeld in Riverside. For further information contact Kelly Houston at (909) 885-2503 |
| | 26 | LITTLE TOKYO WALKING TOUR ~ 10:15am - 12:15pm / Relive history and learn about present-day Little Tokyo with National Museum docents. \$8 Members; \$13 non-members, includes Museum admission. Comfortable walking shoes and clothes recommended. Weather permitting. / www.janm.org |
| | 30 | IKS BUSINESS MEETING ~ 7 pm / <i>All members of IKS welcome!</i> 6531 Box Springs Blvd, Riverside / Gene Maingot at (951) 272-4450. |
| | |    |
| | |  |

| | | |
|----------------------------|-------|---|
| A U G U S T | 01 | REDLANDS SUMMER MUSIC FESTIVAL ~ 8:15 pm. See article at the bottom left for more info. |
| | 08 | AKCA BOARD MEETING ~ 7pm / 529 E. Blueridge Ave Orange, CA 92867 / Call Larry Leverett at (951) 781-3887 for more information. |
| | 15 | REDLANDS SUMMER MUSIC FESTIVAL ~ 8:15 pm. See article at the bottom left for more info. |
| | 16 | FOOD, WINE & FLOWER FESTIVAL ~ at the Crossings at Corona shopping center / 2470 Tuscany Rd., Corona. Exit I-15 at Cajalco Rd. exit. / (951) 284-1050 |
| | 16-24 | 68TH NISEI WEEK JAPANESE FESTIVAL ~ The 68th Nisei Week Japanese Festival, including the Grand Parade, Street Fair and Street Ondo in Little Tokyo Los Angeles. For more information, please call (213) 687-7193 or visit www.niseiweek.org |
| | 22-24 | I. E. JAZZ FESTIVAL 11 ~ Cucamonga-Guasti Regional Park in Ontario www.iejazz.com |
| | 24 | IKS GENERAL MEETING & POTLUCK ~ 3-6 pm . At the home of Pat & Jerry Mall in Temecula. For more info, contact Kelly Houston (909) 885-2503. |
| | 27 | IKS BUSINESS MEETING ~ 7 pm / <i>All members of IKS welcome!</i> 6531 Box Springs Blvd, Riverside / Gene Maingot at (951) 272-4450. |
| | 29-31 | ORANGE INTERNATIONAL STREET FAIR ~ An annual tradition during Labor Day weekend "Around the World In 3 Days" http://orangestreetfair.org |
| | |  |

The Inland Koi Connection is a publication of the Inland Koi Society. Material is selected for the club's interest in ponds, koi, gardening, and other activities. IKS Officers and Directors accept no responsibility for accuracy of content. Reproduction is permitted provided this newsletter is credited as the source. Deadline for newsletter items is the 5th day of each month and items should be submitted directly to Editor, Debby J. Leverett at 5349 Jasper Lane - Riverside, California 92506 Phone: (951) 781-3887 E-mail: jenniferdl1950@hotmail.com



INLAND KOI SOCIETY
5198 ARLINGTON AVE., #146
RIVERSIDE, CA 92504
Return Service Requested

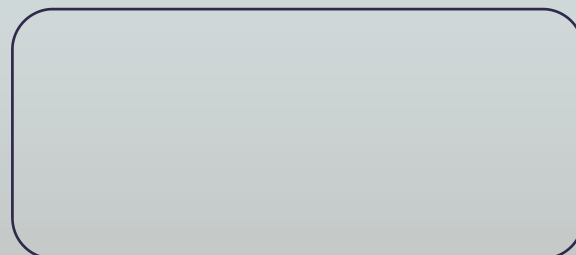

*"One touch of nature makes the whole world kin."
~ William Shakespeare*

"It is not so much for its beauty that the forest makes a claim upon men's hearts, as for that subtle something, that quality of air that emanation from old trees, that so wonderfully changes and renews a weary spirit." ~ Robert Louis Stevens



Visit our website: www.inlandkoi.org